

Fiilex

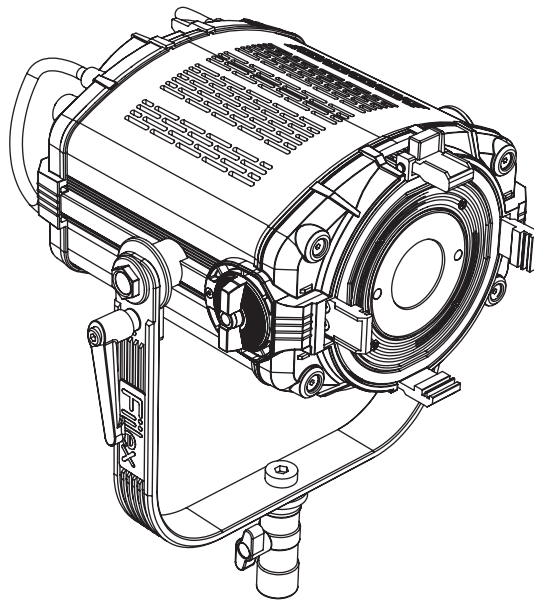

Q500

FLXQ5AC

User Manual

190103A2

General Notes

- The Q500 has been designed for professional studio and location applications and may only be operated by qualified persons.
- Please read the following operating instructions very carefully before using this fixture.
- For your own safety, please follow all safety instructions and warnings.
- Keep these operating instructions for future reference.
- For further information, contact Fiilex (fiilex@fiilex.com) or your retailer.

Basic Operation (refer to Parts Diagram on following page)

- **Turning On**
Insert the powerCON cable into the PowerCON Connection Port (19) and rotate clockwise to lock in place. Plug the light in to an appropriate outlet. The On/Off Button (20) will light red to signify it is in standby mode. Press the On/Off Button (20) to turn on the light. The On/Off Button (20) will light green to signify it is in working mode.
- **Positioning The Q500**
To adjust the Q500, grasp the Handles (11) then loosen the Tilt Lock Lever (10). Adjust the angle to the desired position then tighten the Tilt Lock Lever (10) to secure.
- **Adjusting Beam Angle**
Adjust the beam angle by turning the Focusing Knob (6). The lens tube will extrude back and forth from the lamphead housing.
- **Mounting The Q500**
The Q500 can be mounted the Junior Pin Receiver (7). In order to mount the light, insert the stud of the C-Stand into the Pin Receiver (7) and secure by tightening the Stand Locking Pin (8).
- **DMX Interface**
The Q500 is equipped with two DMX interfaces. RJ45 (23) or XLR ports (21 & 17) are used to send the DMX signal to the lamphead. Both interfaces include in/out ports for the purpose of daisy-chaining the DMX line through to the next lamphead.
- **USB Interface**
The Q500 is equipped with a mini USB port for updating the Q500's firmware. Please register your product at www.fiilex.com to be informed when firmware updates are available.

Mode	On/Off Button Color	Description
Standby	Red	Manual controls enabled but no light output
DMX	Orange	Active DMX signal detected. Manual Controls disabled
Output	Green	Manual controls enabled and there is light output

Parts Diagram

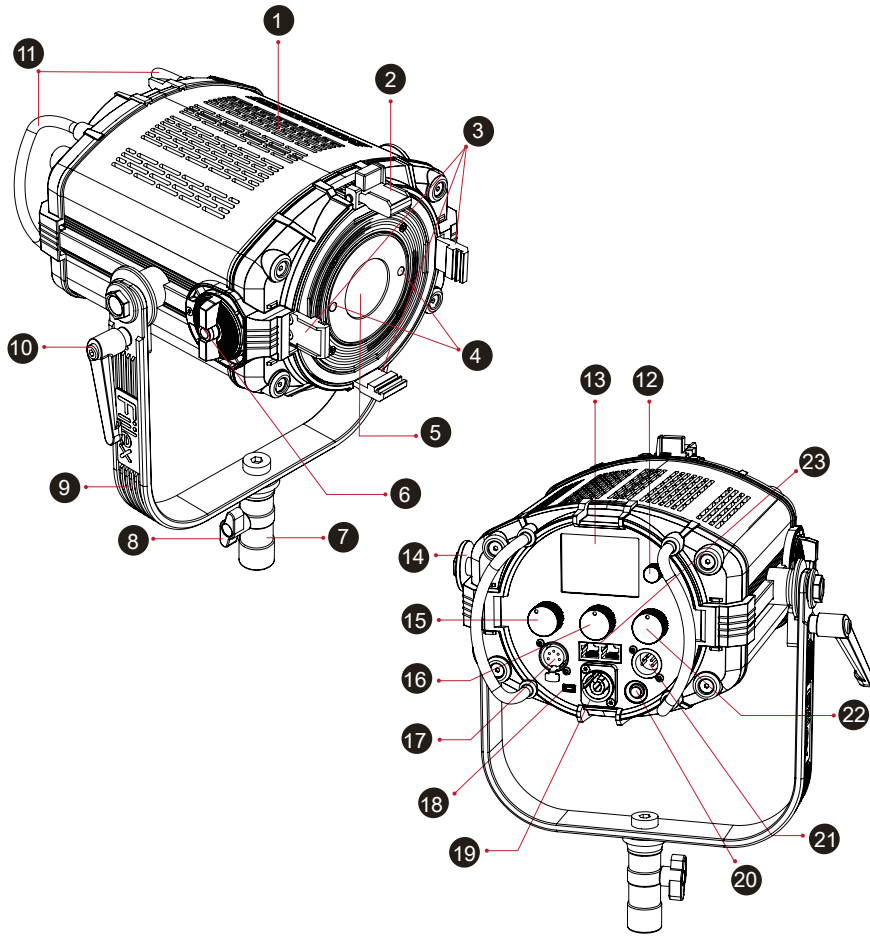

1. Vent Holes
2. Top Accessory Latch
3. Accessory Holder Brackets
4. Magnetic Mount
5. Light Source
6. Focusing Knob
7. Junior Pin Receiver
8. Stand Locking Pin
9. Yoke
10. Tilt Lock Lever
11. Handles
12. DMX Address Knob
13. LCD Display
14. Yoke Bolt
15. CCT Tuning Knob
16. HUE Tuning Knob
17. DMX Output (5-Pin XLR-Female)
18. Mini USB Port
19. Power Input Port
20. On/Off Button
21. DMX Input (5-Pin XLR-Male)
22. Intensity Control Knob
23. RJ45 Ports (DMX In/Out)

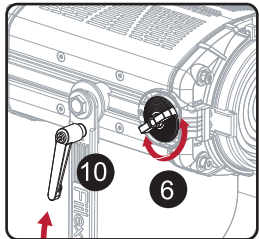

Adjusting the Beam Angle

Use the Tilt Lock Lever (10) to lock the fixture's tilt position. Turn the Focusing Knob (6) to adjust the beam angle.

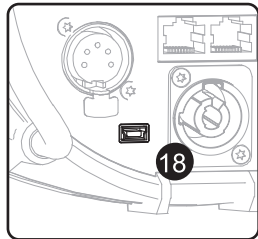

USB Interface

The Q500 is equipped with a Mini USB Port (18) for updating firmware. The port also provides 5V 1A power for wireless DMX antennas.

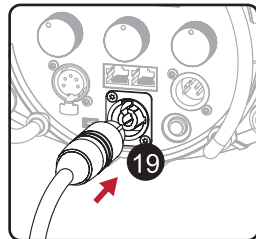

Powering On

Insert the powerCON connector into the Power Input (19). Plug the AC connector into a wall socket.

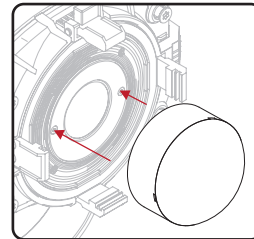

Magnetic Mounting

Two magnets are located on either side of the Light Source (5). Fiilex's magnetic accessories will mount to the Q500 when the 5" Fresnel is removed.

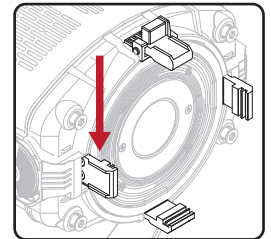

Speed Ring / Barndoor

Non-magnetic light modifiers attach by sliding into Accessory Holder Brackets (3). Close the Top Accessory Latch (2) to secure accessories.

Compatible Accessories

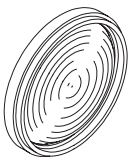

5" Fresnel Lens*

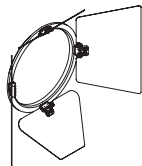

4-Leaf Barndoor*

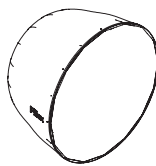

Para Softbox

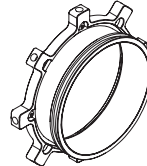

Speed Ring

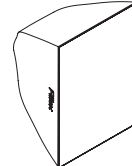

Medium Softbox

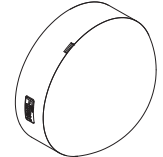

Dome Diffuser

*Included with fixture

Rear Panel Interface Operation

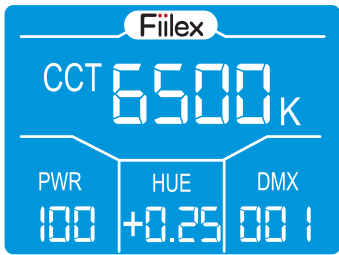

Knob	Function	Range
CCT	Set color temperature	2800K - 6500K
PWR	Set intensity	100% - 0.1%
HUE	Set HUE value	±0.25 Magenta/Green
DMX	Set DMX address	1 - 510

Assigning DMX Address:

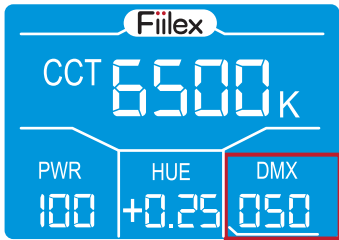

Flashing underscore

1. Double click the DMX Address Knob (12) to activate the DMX Address Section of the LCD Display. Once activated, a blinking line will appear below the DMX Display Area.
2. Turn the DMX Address Knob (12) until desired address appears.
3. Once desired address is displayed on the screen, click the DMX Address Knob to set the address. The new selected address will automatically set after 3 seconds of inactivity.
4. When a DMX address is selected, the Q500 will automatically assign the next two addresses in the following order:
 - (1) Intensity
 - (2) CCT
 - (3) Hue
 - To adjust the fixture's DMX address via RDM, consult operating instructions for DMX/RDM control systems.

Specifications

CCT Range	2800-6500K Continuous Tuning
Light Engine	Dense Matrix LED
Power Draw	185W Max
DC Input	N/A
AC Input	100 - 240V AC, 50 ~ 60Hz
Power Port	powerCON Blue
DMX Ports	XLR-5P (In & Out) and RJ45 (In & Out)
Weight (With Yoke)	12.0lbs / 5.5kg
Size With Yoke (L x W x H)	12.0in x 12.8in x 15.0in / 30.5cm x 35.0cm x 38.0cm
Mount	Baby Stud 5/8" Female (16mm) & Junior Stud 1-1/8" Male (28mm)
Thermal Design	Advanced Vapor Cooling System (Fan Cooled)
Operating Temperature	32 - 104°F / 0 - 40°C
IP Rating	IP-20
LED Lifetime	42,000 hours
Certifications	UL, CE, FCC

Safety

- CAUTION! High Beam Intensity! - Do not look into the Light Source (5) of the fixture.
- Do NOT point the light at combustable or flammable materials.
- Do NOT attempt to disassemble the body of Q500. Doing so will void the warranty.
- Do NOT install Q500 in a damp or wet area.
- Do NOT cover/block the side and back air vents.
- Use only the included power supply. Failure to do so may cause damage to the light.
- Use only a soft, dry towel to gently clean the exterior of the light.
- Do NOT lift or suspend the light by the power cable.
- Do NOT use the Q500 or accessories if they display any physical damage.
- Before first use, make sure to remove all protective membranes.
- Do NOT use the gel holder designed for the P series of lights with the Q500.
- Do NOT mount the Q500 in a hanging position without a separate safety cable.
A safety cable is NOT included with the Q500.

Warranty

Unless otherwise stated, your product is covered by a **one year parts and labor limited warranty**. Fiilex guarantees, to the original buyer, that this product is to be free of defects in both workmanship and material for a period of one year from the date of shipment. This warranty extends to all products which have proved defective through normal use but excludes products that have been disassembled, modified or misused by the buyer or any other person. This warranty is in lieu of all other warranties, and disclaims all warranties expressed or implied, including any warranty of merchantability, fitness for a particular purpose, or arising from the course of dealing between the parties or usage of trade.

Returning an Item Under Warranty for Repair

It is necessary to obtain a Return Authorization Number (RA#) from your dealer/point of purchase BEFORE any units are returned for repair. Fiilex will make the final determination as to whether or not the unit is covered by warranty. Fiilex will replace or repair to proper working condition any products that are returned under warranty. Products repaired or replaced under warranty are under warranty only for the remaining unexpired period of time of the original warranty.

Any Product unit or part returned to Fiilex must be packaged in a suitable manner to ensure the protection of such Product unit or parts. The package must be clearly and prominently marked to indicate that the package contains returned product units or parts with a Return Authorization (RA#) number. All returned product units or parts must be accompanied by a written explanation of the alleged problem or malfunction.



www.fiilex.com

1689 Regatta Blvd. Richmond, CA 94804
| (510) 620-5155 | fiilex@fiilex.com